

## Transient Voltage Suppressors (TVS) Data Sheet

### Features

- For surface mounted applications in order to optimize board space
- Low profile package
- Built-in strain relief
- Glass passivated junction
- Low inductance
- Excellent clamping capability
- 1500W peak pulse power capability at 10/1000 $\mu$ s waveform, repetition rate (duty cycle): 0.01%
- Fast response time
- Typical  $I_R$  less than 1 $\mu$ A above 10V
- High Temperature soldering: 260 $^{\circ}$ C/10 seconds at terminals
- Plastic package has underwriters laboratory flammability 94V-0
- Meets MSL level 1, per J-STD-020
- Safety certification: UL: E244458
- AEC-Q101 qualified



### Mechanical Data

- Case: JEDEC DO-214AB. Molded plastic over glass passivated junction
- Terminal: Solder plated, solderable per MIL-STD-750, Method 2026
- Polarity: Color band denotes cathode except bi-directional models
- Standard Packaging: 16mm tape (EIA STD RS-481)
- Weight: 0.26g

### Applications

- I/O interface
- AC/DC power supply
- Low frequency signal transmission line (RS232, RS485, etc.)

### Maximum Ratings and Characteristics

Ratings at 25 $^{\circ}$ C ambient temperature unless otherwise specified.

Rating	Symbol	Value	Units
Peak pulse power dissipation at 10/1000 $\mu$ s waveform (Note1, Note2, Fig.1)	$P_{PPM}$	Minimum 1500	Watts
Peak pulse current of at 10/1000 $\mu$ s waveform (Note 1, Fig.3)	$I_{PPM}$	See Table	Amps
Steady state power dissipation at $T_A=50^{\circ}$ C (Fig.5)	$P_{M(AV)}$	6.5	Watts
Peak forward surge current, 8.3ms single half sine-wave superimposed on rated load, (JEDEC Method) (Note3, Fig.6)	$I_{FSM}$	200	Amps
Operating junction and Storage Temperature Range.	$T_J, T_{STG}$	-55 to +150	$^{\circ}$ C
Typical thermal resistance junction to lead	$R_{\theta JL}$	15	$^{\circ}$ C/W
Typical thermal resistance junction to ambient	$R_{\theta JA}$	75	$^{\circ}$ C/W

Notes: 1. Non-repetitive current pulse, per Fig.3 and derated above  $T_A=25^{\circ}$ C per Fig.2.

2. Mounted on 8.0mm $\times$ 8.0mm copper pads to each terminal.

3. 8.3ms single half sine-wave, or equivalent square wave, duty cycle=4 pulses per minutes maximum.

**Dimensions (SMC/DO-214AB)**

Symbol	Millimeters		Inches	
	Min.	Max.	Min.	Max.
L	6.60	7.11	0.260	0.280
D	5.59	6.22	0.220	0.245
D1	2.90	3.20	0.114	0.126
T	7.75	8.13	0.305	0.320
T1	0.76	1.52	0.030	0.060
d	-	0.203	-	0.008
H	2.20	2.80	0.087	0.110
H1	2.06	2.62	0.079	0.103

**Electrical Characteristics (T<sub>A</sub>=25°C)**

Part Number		Device Marking Code		Reverse Stand-Off Voltage	Breakdown Voltage @I <sub>T</sub>	Test Current	Maximum Clamping Voltage @I <sub>PP</sub>	Peak Pulse Current	Reverse Leakage @V <sub>RWM</sub>
Unidirectional	Bidirectional	UNI	BI	V <sub>RWM</sub> (V)	V <sub>BR</sub> (V)	I <sub>T</sub> (mA)	V <sub>C</sub> (V)	I <sub>PP</sub> (A)	I <sub>R</sub> (μA)
SMCJ5.0A-AT	SMCJ5.0CA-AT	GDE	BDE	5.0	6.40~7.00	10	9.2	163.0	800
SMCJ6.0A-AT	SMCJ6.0CA-AT	GDG	BDG	6.0	6.67~7.37	10	10.3	145.7	800
SMCJ6.5A-AT	SMCJ6.5CA-AT	GDK	BDK	6.5	7.22~7.98	10	11.2	134.0	500
SMCJ7.0A-AT	SMCJ7.0CA-AT	GDM	BDM	7.0	7.78~8.60	10	12.0	125.0	200
SMCJ7.5A-AT	SMCJ7.5CA-AT	GDP	BDP	7.5	8.33~9.21	1	12.9	116.3	100
SMCJ8.0A-AT	SMCJ8.0CA-AT	GDR	BDR	8.0	8.89~9.83	1	13.6	110.3	50
SMCJ8.5A-AT	SMCJ8.5CA-AT	GDT	BDT	8.5	9.44~10.40	1	14.4	104.2	20
SMCJ9.0A-AT	SMCJ9.0CA-AT	GDV	BDV	9.0	10.00~11.10	1	15.4	97.4	10
SMCJ10A-AT	SMCJ10CA-AT	GDX	BDX	10.0	11.10~12.30	1	17.0	88.3	5
SMCJ11A-AT	SMCJ11CA-AT	GDZ	BDZ	11.0	12.20~13.50	1	18.2	82.5	1
SMCJ12A-AT	SMCJ12CA-AT	GEE	BEE	12.0	13.30~14.70	1	19.9	75.4	1
SMCJ13A-AT	SMCJ13CA-AT	GEG	BEG	13.0	14.40~15.90	1	21.5	69.8	1
SMCJ14A-AT	SMCJ14CA-AT	GEK	BEK	14.0	15.60~17.20	1	23.2	64.7	1
SMCJ15A-AT	SMCJ15CA-AT	GEM	BEM	15.0	16.70~18.50	1	24.4	61.5	1
SMCJ16A-AT	SMCJ16CA-AT	GEP	BEP	16.0	17.80~19.70	1	26.0	57.7	1
SMCJ17A-AT	SMCJ17CA-AT	GER	BER	17.0	18.90~20.90	1	27.6	54.4	1
SMCJ18A-AT	SMCJ18CA-AT	GET	BET	18.0	20.00~22.10	1	29.2	51.4	1
SMCJ20A-AT	SMCJ20CA-AT	GEV	BEV	20.0	22.20~24.50	1	32.4	46.3	1
SMCJ22A-AT	SMCJ22CA-AT	GEX	BEX	22.0	24.40~26.90	1	35.5	42.3	1
SMCJ24A-AT	SMCJ24CA-AT	GEZ	BEZ	24.0	26.70~29.50	1	38.9	38.6	1

Part Number		Device Marking Code		Reverse Stand-Off Voltage	Breakdown Voltage @ I <sub>T</sub>	Test Current	Maximum Clamping Voltage @ I <sub>PP</sub>	Peak Pulse Current	Reverse Leakage @ V <sub>RWM</sub>
Unidirectional	Bidirectional	UNI	BI	V <sub>RWM</sub> (V)	V <sub>BR</sub> (V)	I <sub>T</sub> (mA)	V <sub>C</sub> (V)	I <sub>PP</sub> (A)	I <sub>R</sub> (μA)
SMCJ26A-AT	SMCJ26CA-AT	GFE	BFE	26.0	28.90~31.90	1	42.1	35.7	1
SMCJ28A-AT	SMCJ28CA-AT	GFG	BFG	28.0	31.10~34.40	1	45.4	33.1	1
SMCJ30A-AT	SMCJ30CA-AT	GFK	BFK	30.0	33.30~36.80	1	48.4	31.0	1
SMCJ33A-AT	SMCJ33CA-AT	GFM	BFM	33.0	36.70~40.60	1	53.3	28.2	1
SMCJ36A-AT	SMCJ36CA-AT	GFP	BFP	36.0	40.00~44.20	1	58.1	25.9	1
SMCJ40A-AT	SMCJ40CA-AT	GFR	BFR	40.0	44.40~49.10	1	64.5	23.3	1
SMCJ43A-AT	SMCJ43CA-AT	GFT	BFT	43.0	47.80~52.80	1	69.4	21.7	1
SMCJ45A-AT	SMCJ45CA-AT	GFV	BFV	45.0	50.00~55.30	1	72.7	20.6	1
SMCJ48A-AT	SMCJ48CA-AT	GFX	BFX	48.0	53.30~58.90	1	77.4	19.4	1
SMCJ51A-AT	SMCJ51CA-AT	GFZ	BFZ	51.0	56.70~62.70	1	82.4	18.2	1
SMCJ54A-AT	SMCJ54CA-AT	GGE	BGE	54.0	60.00~66.30	1	87.1	17.3	1
SMCJ58A-AT	SMCJ58CA-AT	GGG	BGG	58.0	64.40~71.20	1	93.6	16.1	1
SMCJ60A-AT	SMCJ60CA-AT	GGK	BGK	60.0	66.70~73.70	1	96.8	15.5	1
SMCJ64A-AT	SMCJ64CA-AT	GGM	BGM	64.0	71.10~78.60	1	103.0	14.6	1
SMCJ70A-AT	SMCJ70CA-AT	GGP	BGP	70.0	77.80~86.00	1	113.0	13.3	1
SMCJ75A-AT	SMCJ75CA-AT	GGR	BGR	75.0	83.30~92.10	1	121.0	12.4	1
SMCJ78A-AT	SMCJ78CA-AT	GGT	BGT	78.0	86.70~95.80	1	126.0	11.9	1
SMCJ85A-AT	SMCJ85CA-AT	GGV	BGV	85.0	94.40~104.00	1	137.0	11.0	1
SMCJ90A-AT	SMCJ90CA-AT	GGX	BGX	90.0	100.00~111.00	1	146.0	10.3	1
SMCJ100A-AT	SMCJ100CA-AT	GGZ	BGZ	100.0	111.00~123.00	1	162.0	9.3	1
SMCJ110A-AT	SMCJ110CA-AT	GHE	BHE	110.0	122.00~135.00	1	177.0	8.5	1
SMCJ120A-AT	SMCJ120CA-AT	GHG	BHG	120.0	133.00~147.00	1	193.0	7.8	1
SMCJ130A-AT	SMCJ130CA-AT	GHK	BHK	130.0	144.00~159.00	1	209.0	7.2	1
SMCJ150A-AT	SMCJ150CA-AT	GHM	BHM	150.0	167.00~185.00	1	243.0	6.2	1
SMCJ160A-AT	SMCJ160CA-AT	GHP	BHP	160.0	178.00~197.00	1	259.0	5.8	1
SMCJ170A-AT	SMCJ170CA-AT	GHR	BHR	170.0	189.00~209.00	1	275.0	5.5	1
SMCJ180A-AT	SMCJ180CA-AT	GHT	BHT	180.0	201.00~222.00	1	292.0	5.1	1
SMCJ190A-AT	SMCJ190CA-AT	GHU	BHU	190.0	211.00~233.00	1	308.0	4.8	1
SMCJ200A-AT	SMCJ200CA-AT	GHV	BHV	200.0	224.00~247.00	1	324.0	4.6	1
SMCJ210A-AT	SMCJ210CA-AT	GHW	BHW	210.0	237.00~263.00	1	340.0	4.4	1
SMCJ220A-AT	SMCJ220CA-AT	GHX	BHX	220.0	246.00~272.00	1	356.0	4.2	1
SMCJ250A-AT	SMCJ250CA-AT	GHZ	BHZ	250.0	279.00~309.00	1	405.0	3.7	1
SMCJ300A-AT	SMCJ300CA-AT	GJE	BJE	300.0	335.00~371.00	1	486.0	3.1	1
SMCJ350A-AT	SMCJ350CA-AT	GJG	BJG	350.0	391.00~432.00	1	567.0	2.6	1
SMCJ400A-AT	SMCJ400CA-AT	GJK	BJK	400.0	447.00~494.00	1	648.0	2.3	1
SMCJ440A-AT	SMCJ440CA-AT	GJM	BJM	440.0	492.00~543.00	1	713.0	2.1	1

Notes: For bidirectional type having V<sub>RWM</sub> of 10V and less, the I<sub>R</sub> limit is double.

**Ratings and Characteristic Curves ( $T_A=25^\circ\text{C}$  unless otherwise noted)**

**Figure 1. Peak Pulse Power Rating Curve**

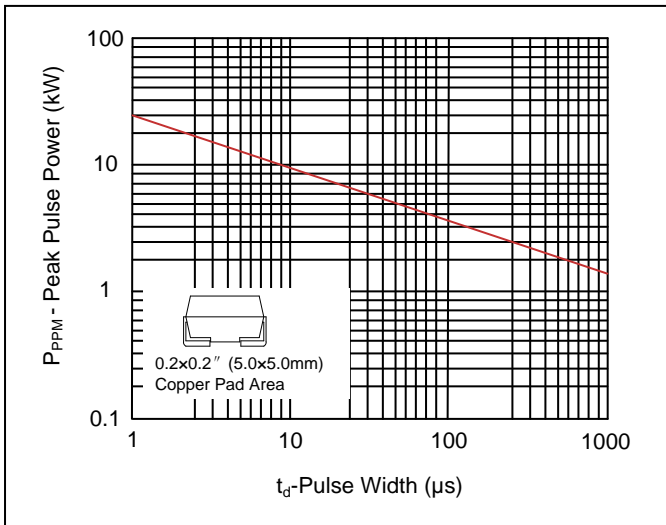

**Figure 2. Pulse Derating Curve**

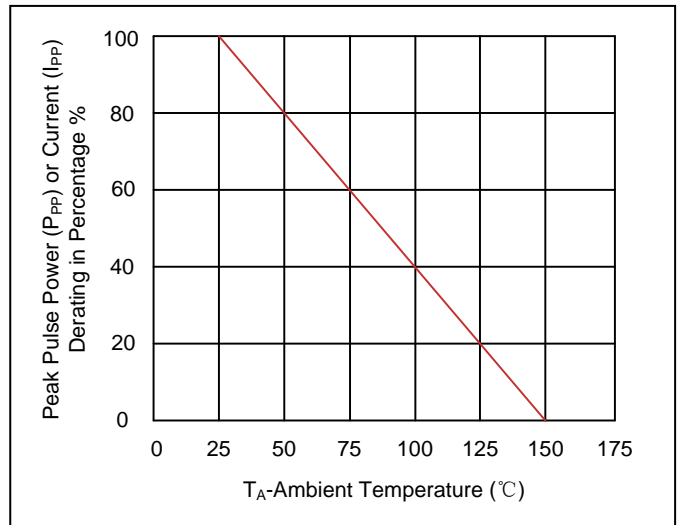

**Figure 3. Pulse Waveform**

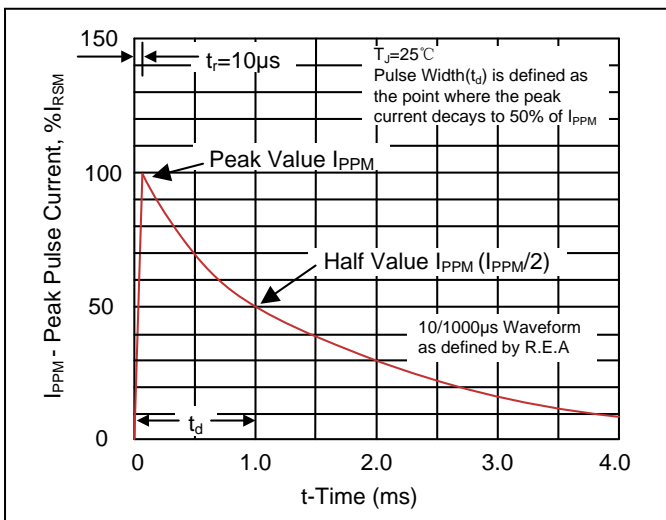

**Figure 4. Typical Junction Capacitance**

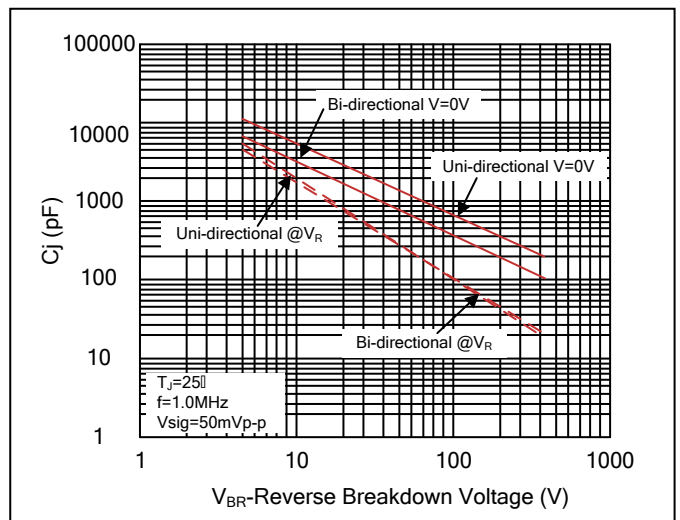

**Figure 5. Steady State Power Dissipation Derating Curve**

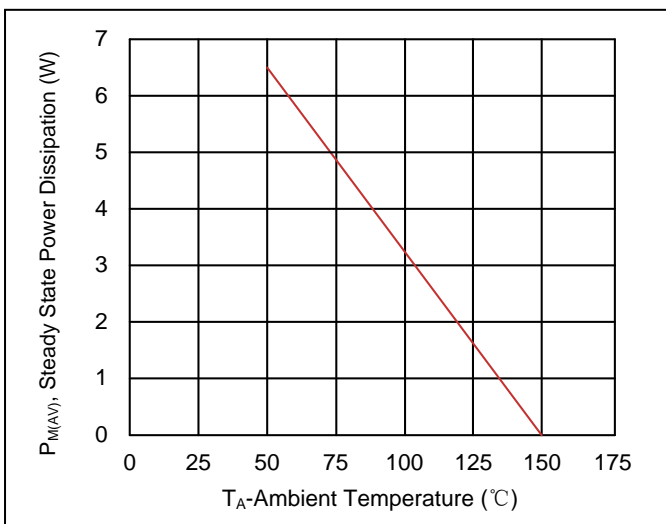

**Figure 6. Maximum Non-Repetitive Forward Surge Current Uni-Directional Only**

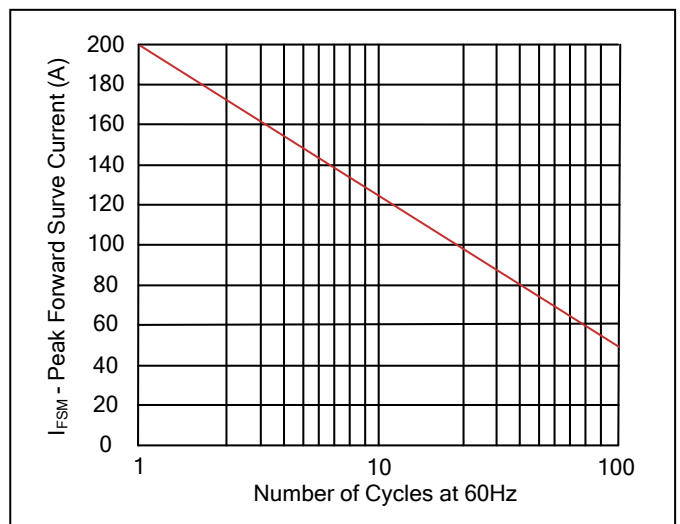

**Recommended Soldering Conditions**

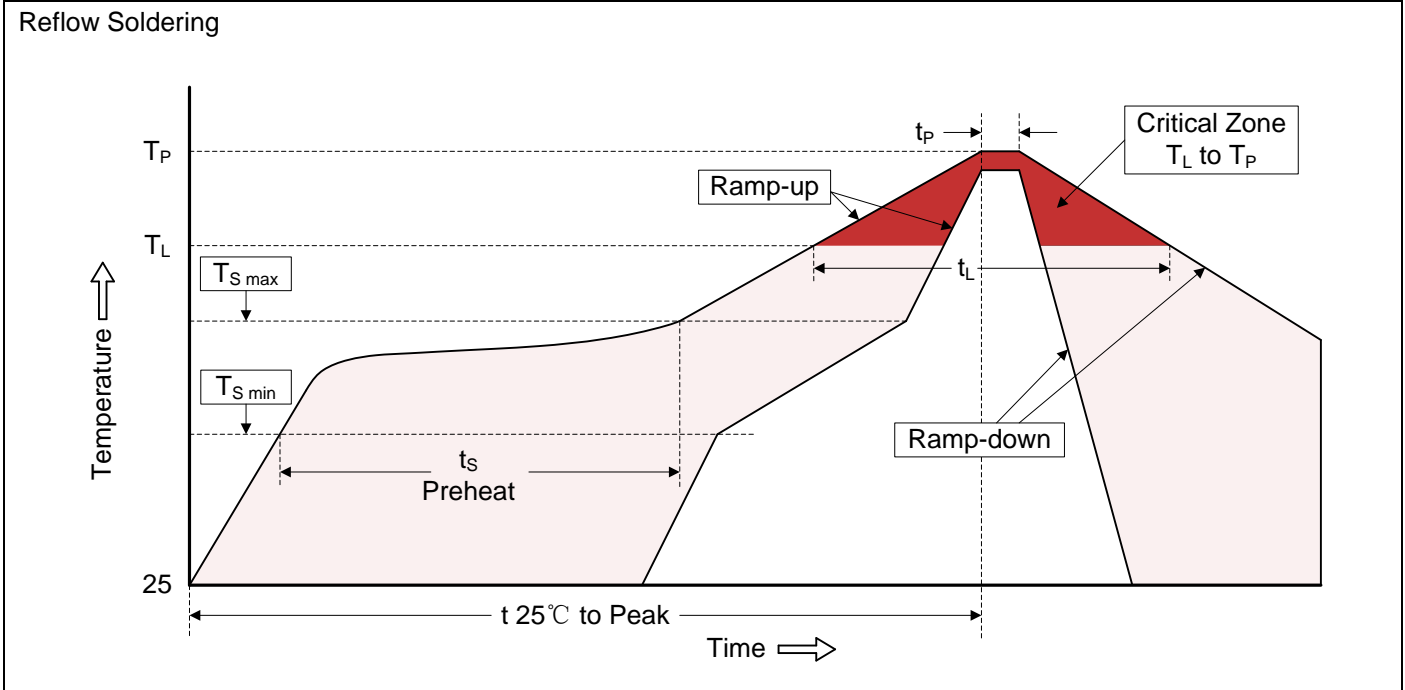

**Recommended Conditions**

Profile Feature	Pb-Free Assembly
Average ramp-up rate ( $T_L$ to $T_P$ )	3°C/second max.
Preheat -Temperature Min ( $T_{S\ min}$ ) -Temperature Max ( $T_{S\ max}$ ) -Time (min to max) ( $t_s$ )	150°C 200°C 60-180 seconds
$T_{S\ max}$ to $T_L$ -Ramp-up Rate	3°C/second max.
Time maintained above: -Temperature ( $T_L$ ) -Time ( $t_L$ )	217°C 60-150 seconds
Peak Temperature ( $T_P$ )	260°C
Time within 5°C of actual Peak Temperature ( $t_p$ )	20-40 seconds
Ramp-down Rate	6°C/second max.
Time 25°C to Peak Temperature	8 minutes max.

**Marking Code**

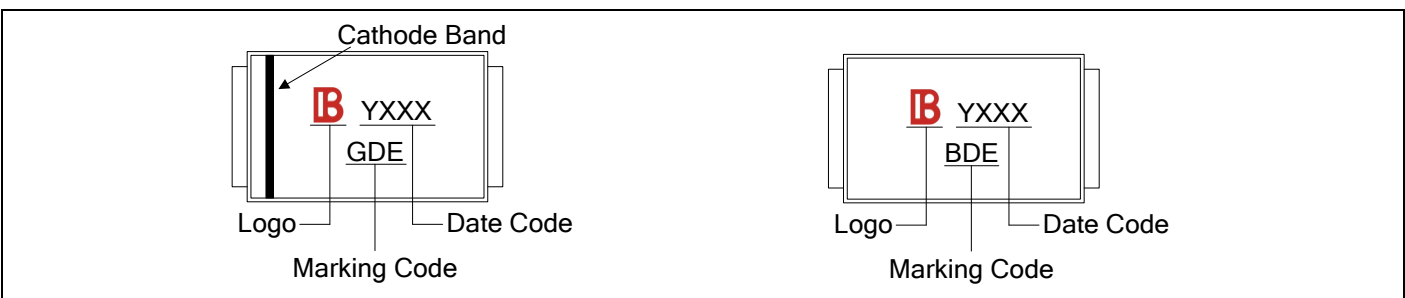

**Part Number Code**

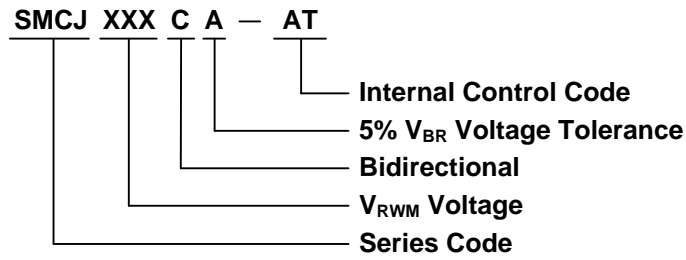

**Packaging**

Tape		Symbol	Dimension (mm)		
		W	16.00±0.20		
		P0	4.00±0.10		
		P1	8.00±0.10		
		P2	2.00±0.10		
		D0	Φ1.5±0.10		
		D1	Φ1.5±0.10		
		E	1.75±0.10		
		F	7.50±0.10		
		A0	6.27±0.10		
		B0	8.30±0.10		
		K0	3.15±0.15		
		T	0.30±0.05		
		<p>7" Reel</p>		D2	Φ178.0±2.0
				D3	Φ50.0Min.
D4	Φ13.0±0.5				
W1	20.0±2.0				
<p>13" Reel</p>		Quantity: 500PCS			
		D5	Φ330.0±2.0		
		D6	Φ13.5±0.5		
		H	2.5±1.0		
		W2	20.0±2.0		
Quantity: 3000PCS					