

## Thyristor Surge Suppressors (TSS) Data Sheet

### Description

**DO-214AA Thyristor** solid state protection thyristor protect telecommunications equipment such as modems, line cards, fax machines, and other CPE.

P Series devices are used to enable equipment to meet various regulatory requirements including GR 1089, ITU K.20, K.21 and K.45, IEC 60950, UL 60950, and TIA-968 (formerly known as FCC Part 68).



### Features

Compared to surge suppression using other technologies, P Series devices offer absolute surge protection regardless of the surge current available and the rate of applied voltage (dv/dt). P Series devices:

- Cannot be damaged by voltage
- Eliminate hysteresis and heat dissipation typically found with clamping devices
- Eliminate voltage overshoot caused by fast-rising transients
- Are non-degenerative
- Will not fatigue
- Have low capacitance, making them ideal for high-speed transmission equipment
- Meets MSL level 1, per J-STD-020

### Electrical Parameters

Parameter	Definition
$V_{DRM}$	<b>Peak Off-state Voltage</b> – maximum voltage that can be applied while maintaining off state
$V_S$	<b>Switching Voltage</b> – maximum voltage prior to switching to on state
$V_T$	<b>On-state Voltage</b> – maximum voltage measured at rated on-state current
$I_{DRM}$	<b>Leakage Current</b> – maximum peak off-state current measured at $V_{DRM}$
$I_S$	<b>Switching Current</b> – maximum current required to switch to on state
$I_T$	<b>On-state Current</b> – maximum rated continuous on-state current
$I_H$	<b>Holding Current</b> – typical current required to maintain on state
$C_O$	<b>Off-state Capacitance</b> – typical capacitance measured in off state
$I_{PP}$	<b>Peak Pulse Current</b> – maximum rated peak impulse current

**Electrical Characteristics**

Part Number	V <sub>DRM</sub> (V)	V <sub>S</sub> (V)	V <sub>T</sub> (V)	I <sub>DRM</sub> (μA)	I <sub>S</sub> (mA)	I <sub>T</sub> (A)	I <sub>H</sub> (mA)	C <sub>O</sub> (pF)	I <sub>PP</sub> 10/1000μs (A)	Power Contact Test	Marking Code
P4200SD	420	550	4	5	800	2.2	30	50	130	275VAC	42D
P6000SD	600	760	4	5	800	2.2	30	40	130	380VAC	60D

Notes:

- All measurements are made at an ambient temperature of 25°C. I<sub>PP</sub> applies to -40°C through +85°C temperature range.
- Off-state capacitance(C<sub>O</sub>) is measured at 1 MHz with a 2V bias and is typical value.
- Rating Surge Voltage: 6KV, ±5 times (10/700μs)

**Thermal Considerations**

Package DO-214AA/SMB	Symbol	Parameter	Value	Unit
	T <sub>J</sub>	Operating Junction Temperature	-40 to +150	°C
	T <sub>S</sub>	Storage Temperature Range	-40 to +150	°C
	R <sub>θJA</sub>	Junction to Ambient on printed circuit	90	°C/W

**Part Number Code and Marking**

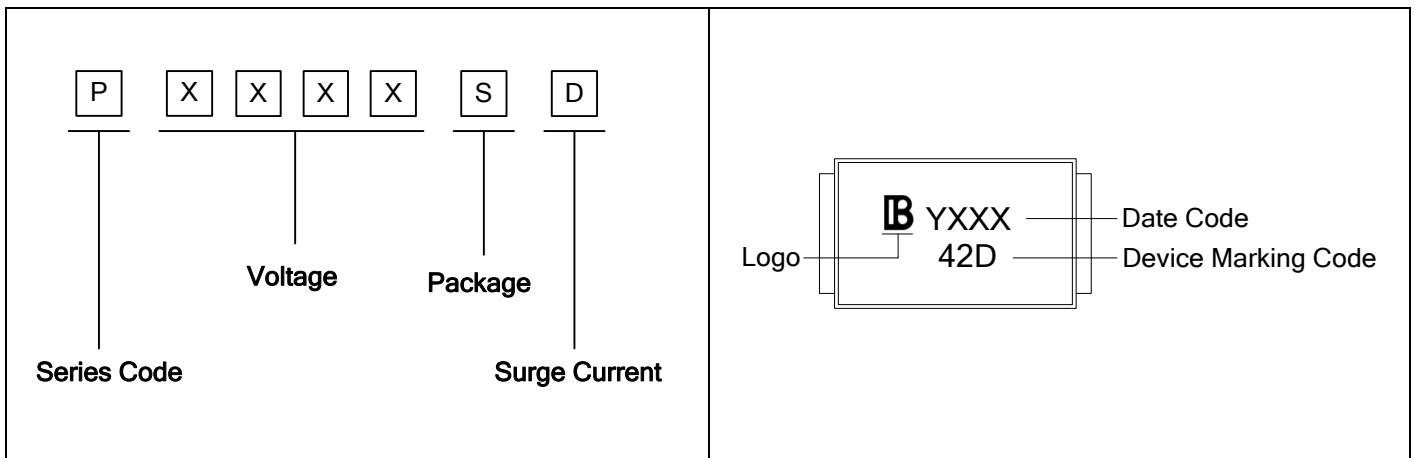

Characteristics Curves

Figure 1. V-I Characteristics

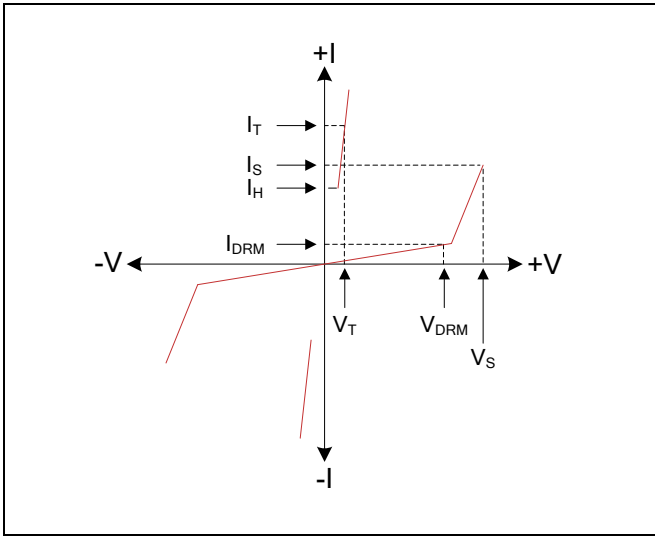

Figure 2.  $t_r \times t_d$  Pulse Wave-form

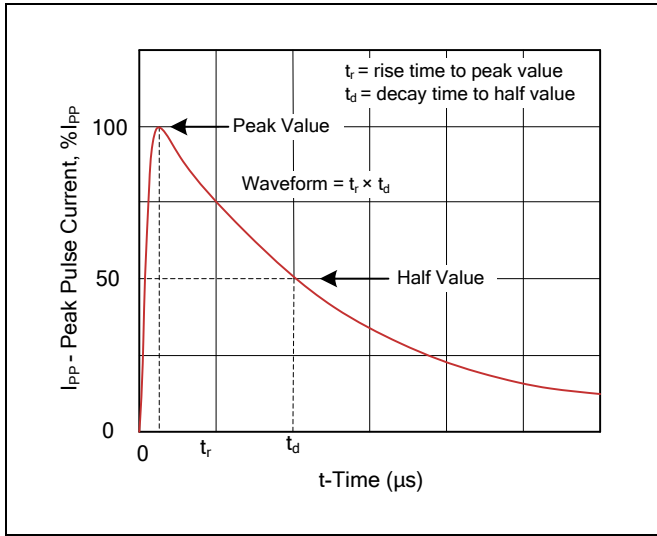

Figure 3. Normalized  $V_S$  Change versus Junction Temperature

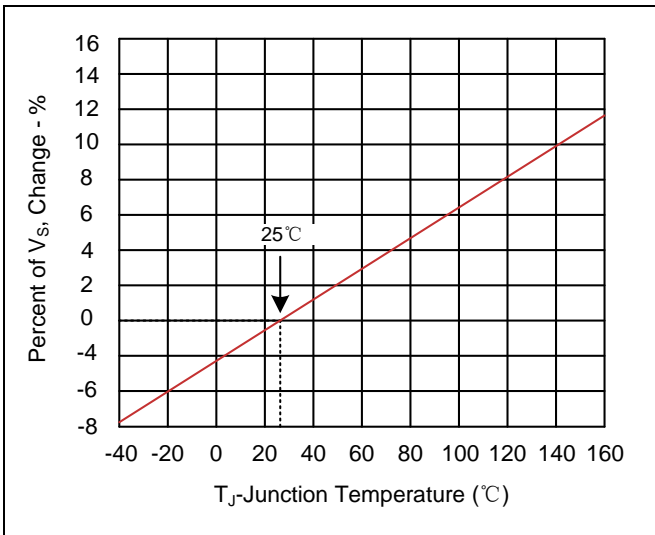
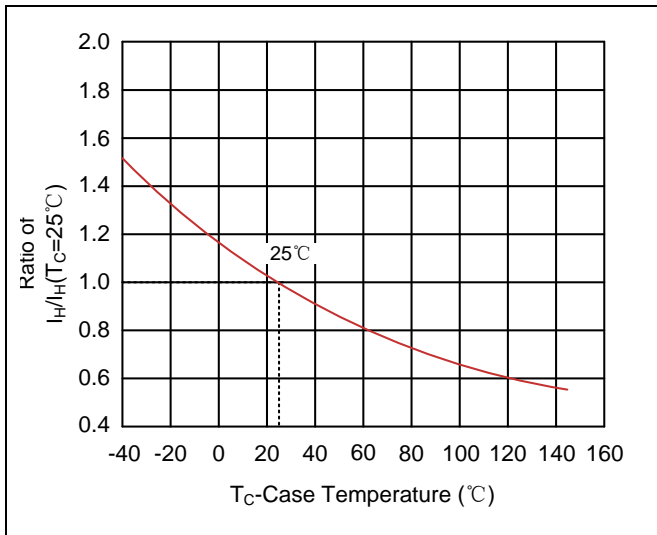
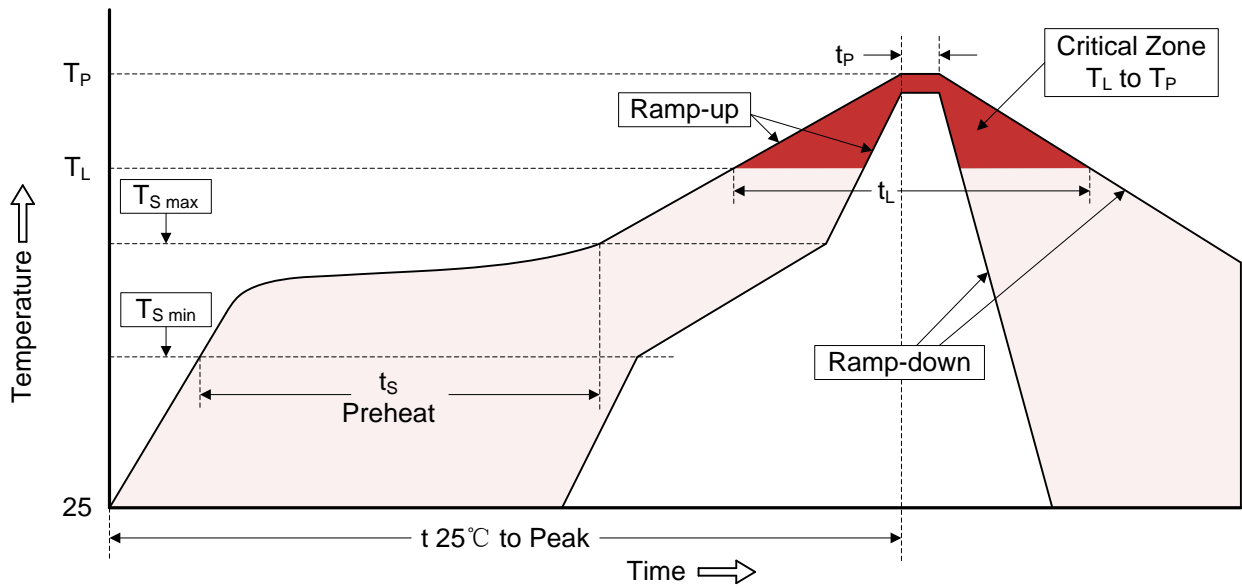

Figure 4. Normalized DC Holding Current versus Case Temperature



Recommended Soldering Conditions

Reflow Soldering



Recommended Conditions

Profile Feature	Pb-Free Assembly
Average ramp-up rate ( $T_L$ to $T_P$ )	3°C/second max.
Preheat -Temperature Min ( $T_{S\ min}$ ) -Temperature Max ( $T_{S\ max}$ ) -Time (min to max) ( $t_s$ )	150°C 200°C 60-180 seconds
$T_{S\ max}$ to $T_L$ -Ramp-up Rate	3°C/second max.
Time maintained above: -Temperature ( $T_L$ ) -Time ( $t_L$ )	217°C 60-150 seconds
Peak Temperature ( $T_P$ )	260°C
Time within 5°C of actual Peak Temperature ( $t_P$ )	20-40 seconds
Ramp-down Rate	6°C/second max.
Time 25°C to Peak Temperature	8 minutes max.

**Dimensions (SMB/DO-214AA)**

Symbol	Millimeters		Inches	
	Min.	Max.	Min.	Max.
L	4.22	4.70	0.166	0.185
D	3.40	3.94	0.134	0.155
D1	1.90	2.20	0.075	0.086
T	5.21	5.59	0.205	0.220
T1	0.91	1.42	0.036	0.056
d	0.05	0.20	0.002	0.008
H	1.95	2.40	0.077	0.095

**Packaging**

Tape		Symbol	Dimension (mm)
		W	12.00±0.30
		P0	4.00±0.10
		P1	8.00±0.10
		P2	2.00±0.10
		D0	Φ1.55±0.05
		D1	Φ1.55±0.05
		E	1.75±0.10
		F	5.50±0.10
		A0	3.76±0.10
		B0	5.69±0.10
		K0	2.70±0.10
		T	0.25±0.10
		D2	Φ330.0±2.0
		D3	Φ13.5±0.5
		H	2.5±0.5
		W1	16.0±1.0
		Quantity: 2500PCS	