

Electrostatic Discharged Protection Devices (ESD) Data Sheet

Description

The UBQ10A05L04-R0.4 is an ultra low capacitance TVS array designed to Protect high speed data interfaces. This series has been specifically Designed to protect sensitive components which are connected to data an transmission lines from overvoltage caused by electrostatic discharge (ESD),cable discharge events (CDE) and lightning.

The unique design incorporates surge rated, low capacitance steering diodes and a TVS diode in a single package. During transient conditions, the steering diodes direct the transient current to ground. The internal TVS diode clamps the transient voltage to a safe level. The ultra low capacitance array configuration allows the user to protect up to the high speed data lines. These devices are in a signal package, RoHS/WEEE compliant, DFN2510 package. It measures 2.5x1.0x0.5mm.



Contact : $\pm 10\text{kV}$
Air : $\pm 10\text{kV}$



Features

- IEC61000-4-2 ESD 10kV Air, 10kV contact compliance
- DFN2510 (2.5x1.0x0.5mm) surface mount package
- Protects four I/O lines
- Working voltage: 5V
- Low leakage current
- Low operating and clamping voltages
- Solid-state silicon avalanche technology
- Lead Free/RoHS compliant
- Solder reflow temperature: Pure Tin-Sn, 260~270°C
- Flammability rating UL 94V-0
- Meets MSL level 1, per J-STD-020
- Marking: B 54

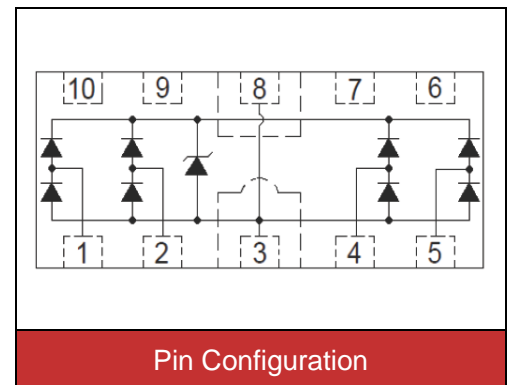

Applications

- High Definition Multimedia Interface (HDMI 1.4)
- Digital Visual Interface (DVI)
- Unified Display Interface (UDI)
- Display Port Interface
- MDDI Ports
- PCI Express
- Serial ATA
- Type C/USB 3.0/USB 2.0

Maximum Ratings

Rating	Symbol	Value	Unit
Peak Pulse Current (tp=8/20μs)	I_{PP}	2	A
ESD voltage (Contact discharge)	V_{ESD}	±10	kV
ESD voltage (Air discharge)		±10	
Storage & operating temperature range	T_{STG}, T_J	-55~+150	°C

Electrical Characteristics ($T_J=25^{\circ}\text{C}$)

Parameter	Symbol	Condition	Min.	Typ.	Max.	Unit
Reverse stand-off voltage	V_{RWM}				5	V
Reverse breakdown voltage	V_{BR}	$I_{BR}=1.0\text{mA}$	6			V
Reverse leakage current	I_R	$V_R=5.0\text{V}$			1	μA
Clamping voltage (tp=8/20μs)	V_C	$I_{PP}=2.0\text{A}$		10		V
Off state junction capacitance	C_J	0Vdc, f=1MHz		0.35	0.4	pF

Typical Characteristics Curves

Figure 1. Capacitance vs. Bias Voltage

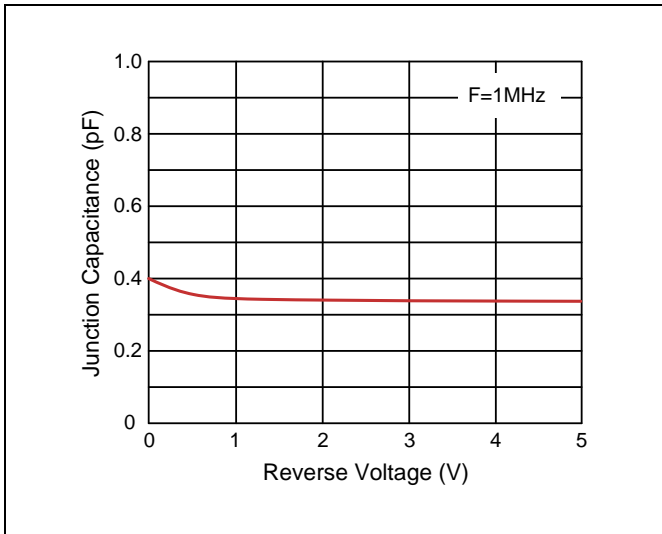

Figure 2. Insertion Loss I/O to GND

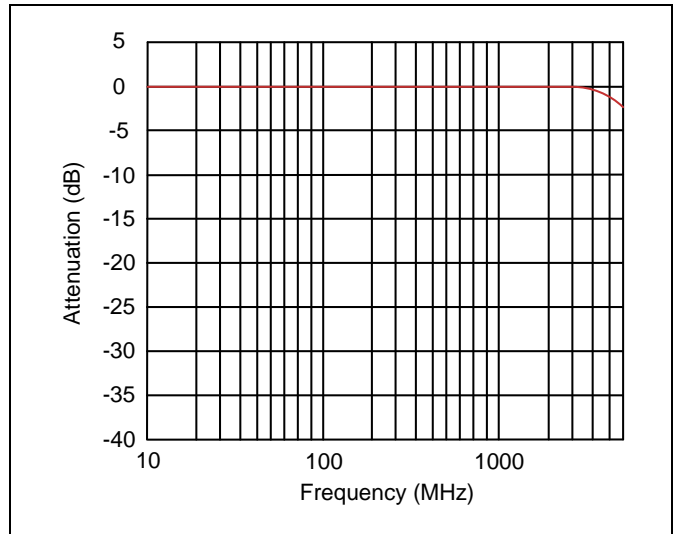

Figure 3. Pulse Waveform

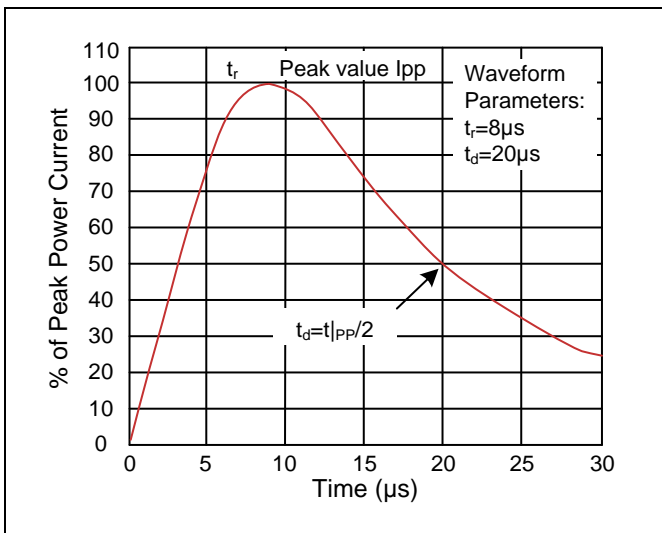
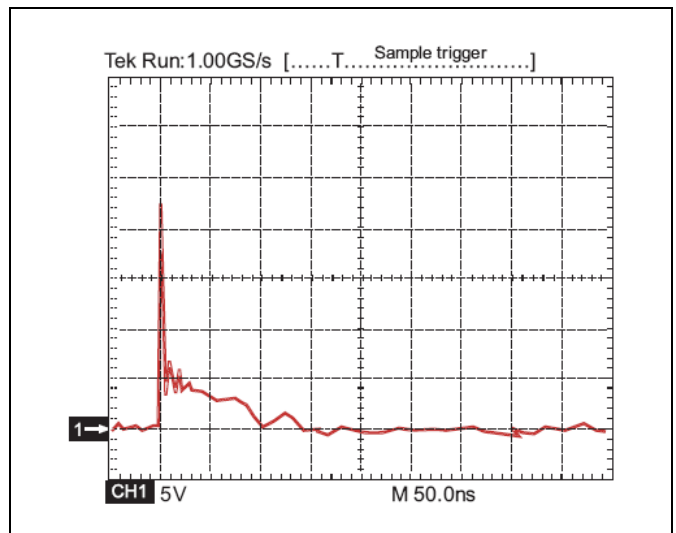
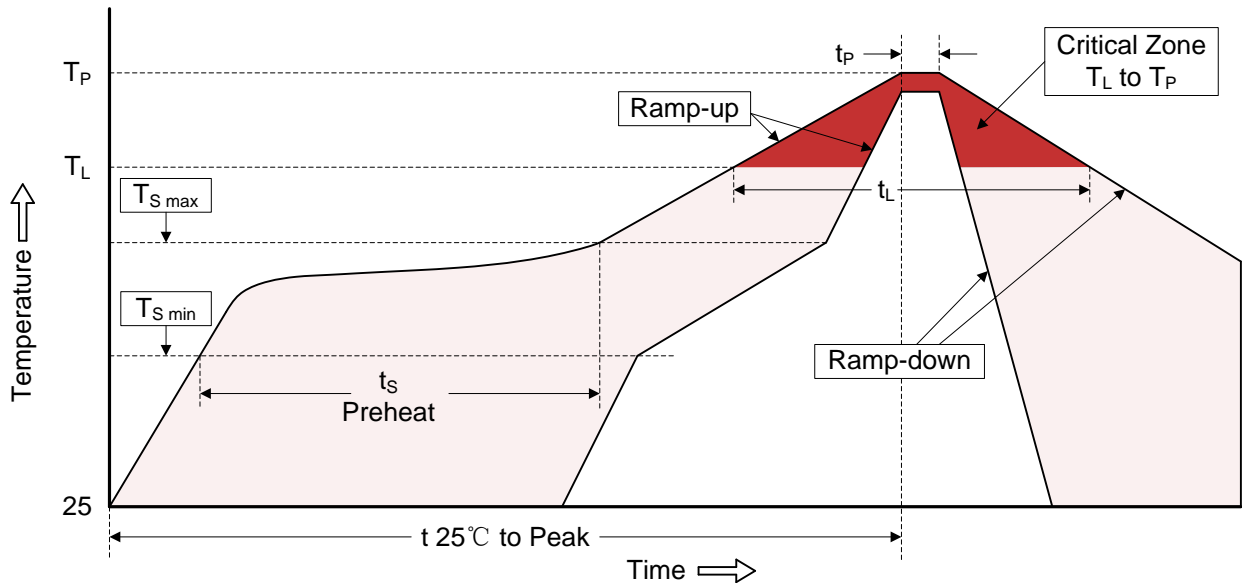

Figure 4. ESD Clamping (8kV Contact IEC61000-4-2)



Recommended Soldering Conditions

Reflow Soldering



Recommended Conditions

Profile Feature	Pb-Free Assembly
Average ramp-up rate (T_L to T_P)	3°C/second max.
Preheat -Temperature Min ($T_{S\ min}$) -Temperature Max ($T_{S\ max}$) -Time (min to max) (t_s)	150°C 200°C 60-180 seconds
$T_{S\ max}$ to T_L -Ramp-up Rate	3°C/second max.
Time maintained above: -Temperature (T_L) -Time (t_L)	217°C 60-150 seconds
Peak Temperature (T_P)	260°C
Time within 5°C of actual Peak Temperature (t_P)	20-40 seconds
Ramp-down Rate	6°C/second max.
Time 25°C to Peak Temperature	8 minutes max.

Dimensions (DFN2510)

Symbol	Dimension					
	Millimeters			Inches		
	Min.	Nom.	Max.	Min.	Nom.	Max.
A	0.45	0.55	0.65	0.018	0.022	0.026
A1	-	0.03	0.05	-	0.001	0.002
A2	0.13REF			0.005REF		
b1	0.15	0.20	0.25	0.006	0.008	0.010
b2	0.35	0.40	0.45	0.014	0.016	0.018
D	2.40	2.50	2.60	0.094	0.098	0.102
E	0.90	1.00	1.10	0.035	0.039	0.043
e	0.50BSC			0.020BSC		
L	0.30	0.38	0.43	0.012	0.015	0.017

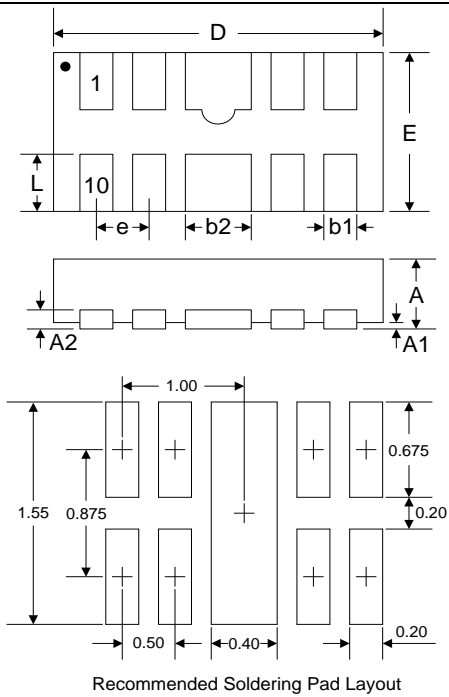

Packaging

Tape	Symbol	Dimension (mm)
	W	8.00±0.30
	P0	4.00±0.10
	P1	4.00±0.10
	P2	2.00±0.10
	D0	Φ1.55±0.10
	D1	Φ0.80±0.05
	E	1.75±0.10
	F	3.50±0.10
	A	1.22±0.10
	B	2.70±0.10
	K	0.70±0.05
	t	0.25±0.05

Reel	Symbol	Dimension (mm)
	D	Φ178.0±2.0
	D2	Φ13.0
	W1	9.5
		Quantity: 3000PCS