

Transient Voltage Suppressors (TVS) Data Sheet

Features

- For surface mounted applications in order to optimize board space
- Low profile package
- Glass passivated junction
- Low inductance
- Excellent clamping capability
- 400W peak pulse power capability at 10/1000 μ s waveform, repetition rate (duty cycle): 0.01%
- Fast response time
- Typical I_R less than 1 μ A above 10V
- High Temperature soldering: 260 $^{\circ}$ C/10 seconds at terminals
- Plastic package has underwriters laboratory flammability 94V-0
- Meets MSL level 1, per J-STD-020
- Safety certification: UL: E244458



Mechanical Data

- Case: JEDEC DO-214AC. Molded plastic over glass passivated junction
- Terminal: Solder plated, solderable per MIL-STD-750, Method 2026
- Polarity: Color band denotes cathode except bi-directional models
- Standard Packaging: 12mm tape (EIA STD RS-481)
- Weight: 0.07g

Applications

- I/O interface
- AC/DC power supply
- Low frequency signal transmission line (RS232, RS485, etc.)

Maximum Ratings and Characteristics

Ratings at 25 $^{\circ}$ C ambient temperature unless otherwise specified.

Rating	Symbol	Value	Units
Peak pulse power dissipation at 10/1000 μ s waveform (Note1, Note2, Fig.1)	P_{PPM}	Minimum 400	Watts
Peak pulse current of at 10/1000 μ s waveform (Note 1, Fig.3)	I_{PPM}	See Table	Amps
Steady state power dissipation at $T_A=50^{\circ}$ C (Fig.5)	$P_{M(AV)}$	3.3	Watts
Peak forward surge current, 8.3ms single half sine-wave superimposed on rated load, (JEDEC Method) (Note3, Fig.6)	I_{FSM}	40	Amps
Operating junction and Storage Temperature Range.	T_J, T_{STG}	-55 to +150	$^{\circ}$ C
Typical thermal resistance junction to lead	$R_{\theta JL}$	30	$^{\circ}$ C/W
Typical thermal resistance junction to ambient	$R_{\theta JA}$	120	$^{\circ}$ C/W

Notes: 1. Non-repetitive current pulse, per Fig.3 and derated above $T_A=25^{\circ}$ C per Fig.2.

2. Mounted on 5.0mmx5.0mm (0.03mm thick) copper pads to each terminal.

3. 8.3ms single half sine-wave, or equivalent square wave, duty cycle=4 pulses per minutes maximum.

Dimensions (SMA/DO-214AC)

Symbol	Millimeters		Inches	
	Min.	Max.	Min.	Max.
L	3.99	4.50	0.157	0.177
D	2.54	2.79	0.100	0.110
D1	1.25	1.65	0.049	0.065
T	4.93	5.28	0.194	0.208
T1	0.76	1.52	0.030	0.060
d	-	0.203	-	0.008
H	2.00	2.50	0.079	0.098
H1	1.98	2.29	0.078	0.090

Electrical Characteristics (T_A=25°C)

Part Number		Device Marking Code		Reverse Stand-Off Voltage	Breakdown Voltage @I _T	Test Current	Maximum Clamping Voltage @I _{PP}	Peak Pulse Current	Reverse Leakage @V _{RWM}
Unidirectional	Bidirectional	UNI	BI	V _{RWM} (V)	V _{BR} (V)	I _T (mA)	V _C (V)	I _{PP} (A)	I _R (μA)
P4SMA6.8A	P4SMA6.8CA	6V8A	6V8C	5.80	6.45~7.14	10	10.5	39.0	1000
P4SMA7.5A	P4SMA7.5CA	7V5A	7V5C	6.40	7.13~7.88	10	11.3	36.3	500
P4SMA8.2A	P4SMA8.2CA	8V2A	8V2C	7.02	7.79~8.61	10	12.1	33.9	200
P4SMA9.1A	P4SMA9.1CA	9V1A	9V1C	7.78	8.65~9.55	1	13.4	30.6	50
P4SMA10A	P4SMA10CA	10A	10C	8.55	9.50~10.50	1	14.5	28.3	10
P4SMA11A	P4SMA11CA	11A	11C	9.40	10.50~11.60	1	15.6	26.3	5
P4SMA12A	P4SMA12CA	12A	12C	10.20	11.40~12.60	1	16.7	24.6	5
P4SMA13A	P4SMA13CA	13A	13C	11.10	12.40~13.70	1	18.2	22.5	1
P4SMA15A	P4SMA15CA	15A	15C	12.80	14.30~15.80	1	21.2	19.3	1
P4SMA16A	P4SMA16CA	16A	16C	13.60	15.20~16.80	1	22.5	18.2	1
P4SMA18A	P4SMA18CA	18A	18C	15.30	17.10~18.90	1	25.2	16.1	1
P4SMA20A	P4SMA20CA	20A	20C	17.10	19.00~21.00	1	27.7	14.8	1
P4SMA22A	P4SMA22CA	22A	22C	18.80	20.90~23.10	1	30.6	13.4	1
P4SMA24A	P4SMA24CA	24A	24C	20.50	22.80~25.20	1	33.2	12.3	1
P4SMA27A	P4SMA27CA	27A	27C	23.10	25.70~28.40	1	37.5	10.9	1
P4SMA30A	P4SMA30CA	30A	30C	25.60	28.50~31.50	1	41.4	9.9	1
P4SMA33A	P4SMA33CA	33A	33C	28.20	31.40~34.70	1	45.7	9.0	1
P4SMA36A	P4SMA36CA	36A	36C	30.80	34.20~37.80	1	49.9	8.2	1
P4SMA39A	P4SMA39CA	39A	39C	33.30	37.10~41.00	1	53.9	7.6	1

Part Number		Device Marking Code		Reverse Stand-Off Voltage	Breakdown Voltage @ I_T	Test Current	Maximum Clamping Voltage @ I_{PP}	Peak Pulse Current	Reverse Leakage @ V_{RWM}
Unidirectional	Bidirectional	UNI	BI	$V_{RWM}(V)$	$V_{BR}(V)$	$I_T(mA)$	$V_C(V)$	$I_{PP}(A)$	$I_R(\mu A)$
P4SMA43A	P4SMA43CA	43A	43C	36.80	40.90~45.20	1	59.3	6.9	1
P4SMA47A	P4SMA47CA	47A	47C	40.20	44.70~49.40	1	64.8	6.3	1
P4SMA51A	P4SMA51CA	51A	51C	43.60	48.50~53.60	1	70.1	5.8	1
P4SMA56A	P4SMA56CA	56A	56C	47.80	53.20~58.80	1	77.0	5.3	1
P4SMA62A	P4SMA62CA	62A	62C	53.00	58.90~65.10	1	85.0	4.8	1
P4SMA68A	P4SMA68CA	68A	68C	58.10	64.60~71.40	1	92.0	4.5	1
P4SMA75A	P4SMA75CA	75A	75C	64.10	71.30~78.80	1	103.0	4.0	1
P4SMA82A	P4SMA82CA	82A	82C	70.10	77.90~86.10	1	113.0	3.6	1
P4SMA91A	P4SMA91CA	91A	91C	77.80	86.50~95.50	1	125.0	3.3	1
P4SMA100A	P4SMA100CA	100A	100C	85.50	95.00~105.00	1	137.0	3.0	1
P4SMA110A	P4SMA110CA	110A	110C	94.00	105.00~116.00	1	152.0	2.7	1
P4SMA120A	P4SMA120CA	120A	120C	102.00	114.00~126.00	1	165.0	2.5	1
P4SMA130A	P4SMA130CA	130A	130C	111.00	124.00~137.0	1	179.0	2.3	1
P4SMA150A	P4SMA150CA	150A	150C	128.00	143.00~158.0	1	207.0	2.0	1
P4SMA160A	P4SMA160CA	160A	160C	136.00	152.00~168.0	1	219.0	1.9	1
P4SMA170A	P4SMA170CA	170A	170C	145.00	162.00~179.0	1	234.0	1.8	1
P4SMA180A	P4SMA180CA	180A	180C	154.00	171.00~189.0	1	246.0	1.7	1
P4SMA200A	P4SMA200CA	200A	200C	171.00	190.00~210.0	1	274.0	1.5	1
P4SMA220A	P4SMA220CA	220A	220C	185.00	209.00~231.0	1	328.0	1.3	1
P4SMA250A	P4SMA250CA	250A	250C	214.00	237.00~263.0	1	344.0	1.2	1
P4SMA300A	P4SMA300CA	300A	300C	256.00	285.00~315.0	1	414.0	1.0	1
P4SMA350A	P4SMA350CA	350A	350C	300.00	332.00~368.0	1	482.0	0.9	1
P4SMA400A	P4SMA400CA	400A	400C	342.00	380.00~420.0	1	548.0	0.8	1
P4SMA440A	P4SMA440CA	440A	440C	376.00	418.00~462.0	1	602.0	0.7	1
P4SMA480A	P4SMA480CA	480A	480C	408.00	456.00~504.0	1	658.0	0.6	1
P4SMA510A	P4SMA510CA	510A	510C	434.00	485.00~535.0	1	698.0	0.6	1
P4SMA530A	P4SMA530CA	530A	530C	450.00	503.50~556.5	1	725.0	0.6	1
P4SMA540A	P4SMA540CA	540A	540C	459.00	513.00~567.0	1	740.0	0.5	1
P4SMA550A	P4SMA550CA	550A	550C	467.00	522.50~577.5	1	760.0	0.5	1

Notes: For bidirectional type having V_{RWM} of 10V and less, the I_R limit is double.

Ratings and Characteristic Curves ($T_A=25^\circ\text{C}$ unless otherwise noted)

Figure 1. Peak Pulse Power Rating Curve

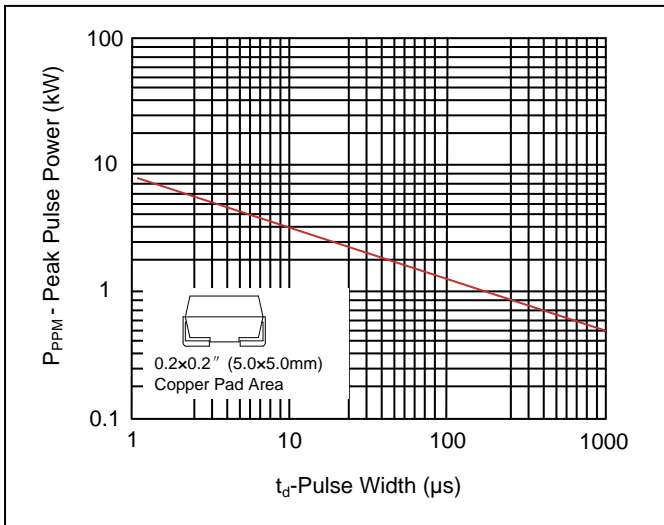

Figure 2. Pulse Derating Curve

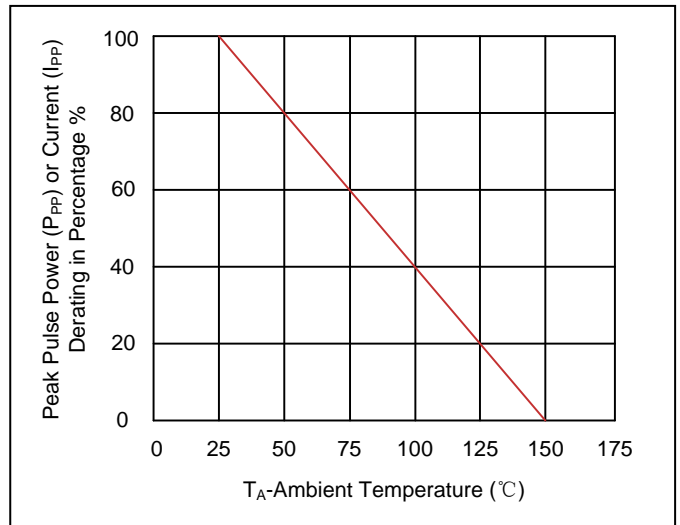

Figure 3. Pulse Waveform

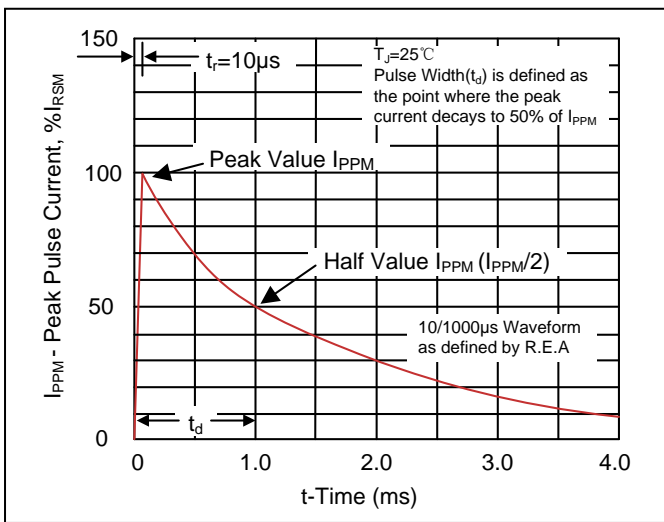

Figure 4. Typical Junction Capacitance

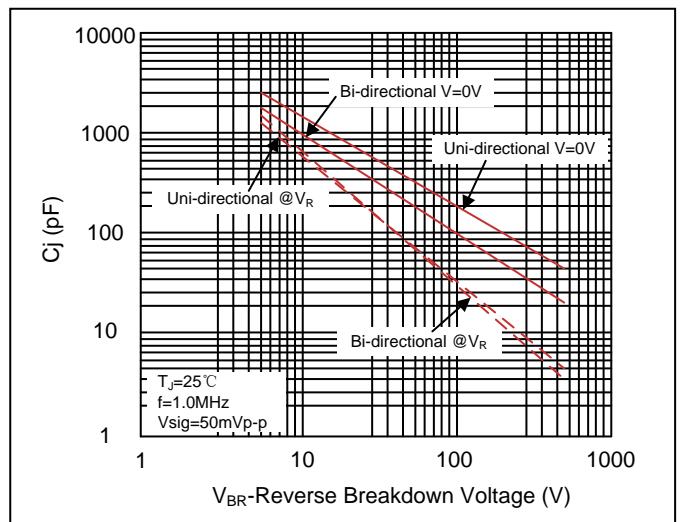

Figure 5. Steady State Power Dissipation Derating Curve

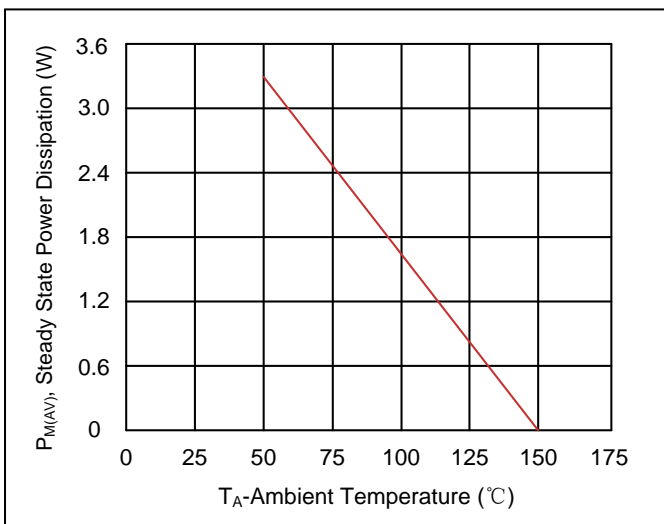
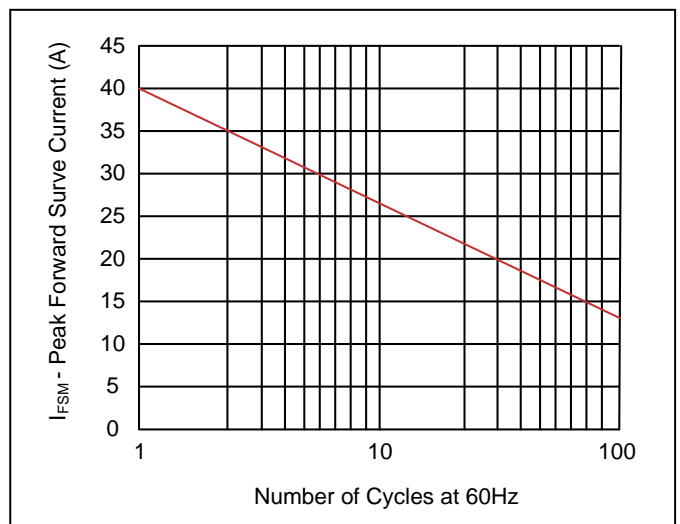
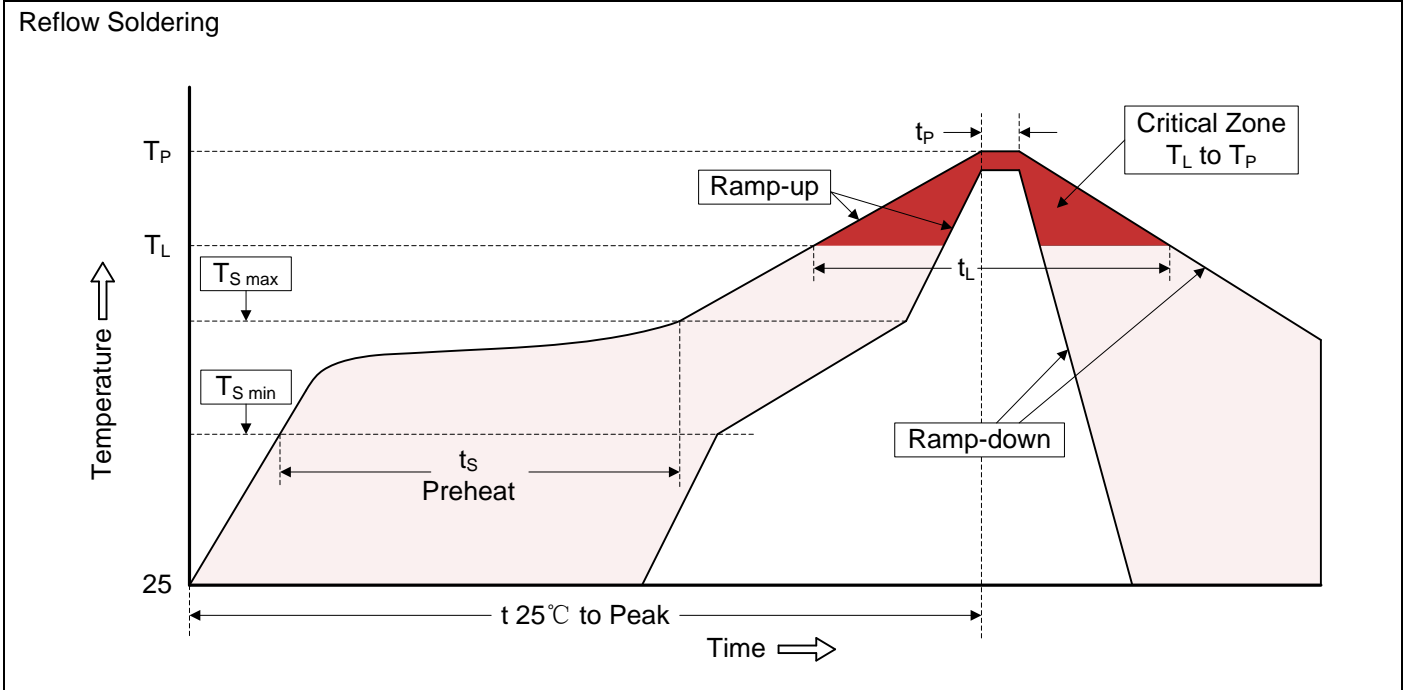

Figure 6. Maximum Non-Repetitive Forward Surge Current Uni-Directional Only



Recommended Soldering Conditions



Recommended Conditions

Profile Feature	Pb-Free Assembly
Average ramp-up rate (T_L to T_P)	3°C/second max.
Preheat -Temperature Min ($T_{S\ min}$) -Temperature Max ($T_{S\ max}$) -Time (min to max) (t_s)	150°C 200°C 60-180 seconds
$T_{S\ max}$ to T_L -Ramp-up Rate	3°C/second max.
Time maintained above: -Temperature (T_L) -Time (t_L)	217°C 60-150 seconds
Peak Temperature (T_P)	260°C
Time within 5°C of actual Peak Temperature (t_p)	20-40 seconds
Ramp-down Rate	6°C/second max.
Time 25°C to Peak Temperature	8 minutes max.

Marking Code

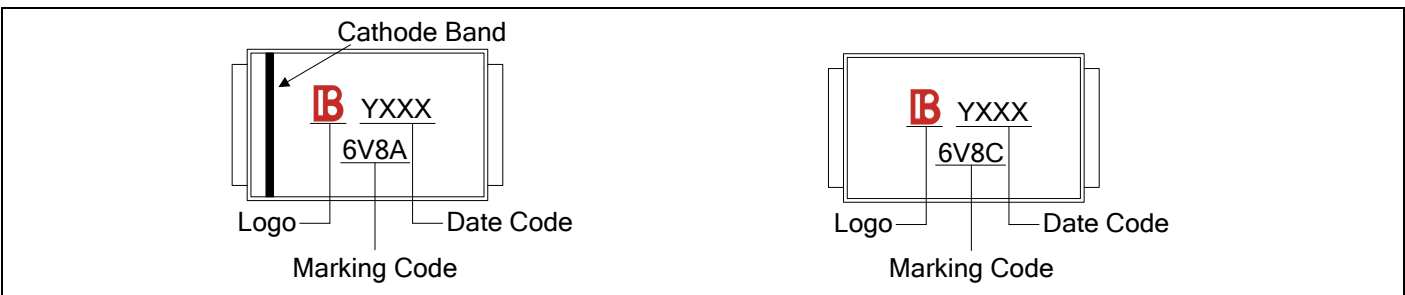

Part Number Code

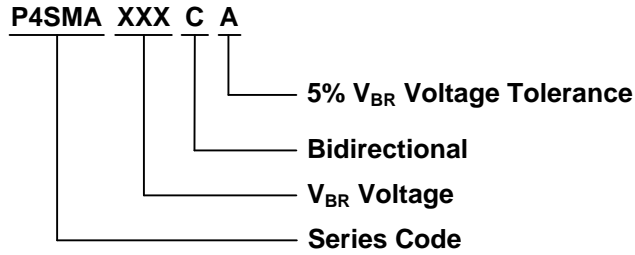

Packaging

Tape		Symbol	Dimension (mm)		
		W	12.00±0.20		
		P0	4.00±0.10		
		P1	4.00±0.10		
		P2	2.00±0.10		
		D0	Φ1.5±0.10		
		D1	Φ1.5±0.10		
		E	1.75±0.10		
		F	5.50±0.05		
		A0	2.79±0.10		
		B0	5.33±0.10		
		K0	2.55±0.15		
		T	0.25±0.05		
		7" Reel		D2	Φ178.0±2.0
				D3	Φ50.0Min.
D4	Φ13.0±0.5				
W1	16.0±2.0				
Quantity: 1000PCS					
13" Reel				D5	Φ330.0±2.0
		D6	Φ13.5±0.5		
		H	2.5±1.0		
		W2	16.0±2.0		
		Quantity: 5000PCS			