

Electrostatic Discharged Protection Devices (ESD) Data Sheet

Description

Brightking's SDT23CXXL02 series are designed to protect sensitive electronics from damage or latch-up due to ESD and other voltage induced transient events. They are designed for use in applications where board space is at a premium. The devices will protect up to two lines. They are bidirectional devices and may be used on lines where the signal polarities are above ground. TVS diodes are solid state device designed specifically for transient suppression.

They feature large cross-sectional area junctions for conduction high transient currents. They offer desirable characteristics for board level protection including fast response time, low and clamping voltage, and no device degradation. The devices may be used to meet the immunity requirements of IEC61000-4-2, level 4. The size SOT-23 package makes them ideal for use in portable electronics such as RS-422 I/Os, RS-232 I/Os, notebook computers, and servers.



Contact : $\pm 8\text{kV}$
Air : $\pm 15\text{kV}$



Features

- IEC61000-4-2 ESD 15KV Air, 8KV contact compliance
- SOT-23 surface mount package
- Protects bidirectional two I/O lines
- Peak power dissipation of 350W under 8/20 μs waveform
- Working voltage: 5V, 12V & 15V
- Low leakage current
- Low operating and clamping voltages
- Solid-state silicon avalanche technology
- Lead Free/RoHS compliant
- Solder reflow temperature: Pure Tin-Sn, 260~270°C
- Flammability rating UL 94V-0
- Meets MSL level 1, per J-STD-020

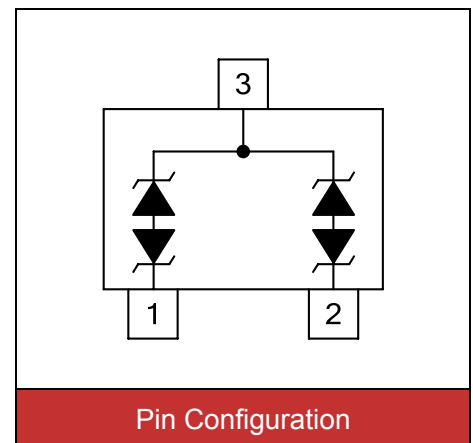

Applications

- RS-232 and RS-422 data lines
- Microprocessor based equipment
- LAN/WAN equipment
- Desktops PC and servers
- Notebook, Laptop and Palmtop computers
- Set Top Box
- Peripherals
- Serial and Parallel ports

Maximum Ratings

Rating	Symbol	Value	Unit
Peak pulse power (tp=8/20μs waveform)	P _{PP}	350	W
ESD voltage (Contact discharge)	V _{ESD}	±8	kV
ESD voltage (Air discharge)		±15	
Storage & operating temperature range	T _{STG} , T _J	-55~+150	°C

Electrical Characteristics (T_J=25°C)

SDT23C05L02 (Marking: C05)

Parameter	Symbol	Condition	Min.	Typ.	Max.	Unit
Reverse stand-off voltage	V _{RWM}				5	V
Reverse breakdown voltage	V _{BR}	I _{BR} =1mA	6			V
Reverse leakage current	I _R	V _R =5V Each I/O pin			5	μA
Clamping voltage (tp=8/20μs)	V _C	I _{PP} =1A			9.8	V
Clamping voltage (tp=8/20μs)	V _C	I _{PP} =10A			18	V
Off state junction capacitance	C _J	0Vdc, f=1MHz Between I/O pins and GND		150		pF

Electrical Characteristics ($T_J=25^{\circ}\text{C}$)

SDT23C12L02 (Marking: C12)

Parameter	Symbol	Condition	Min.	Typ.	Max.	Unit
Reverse stand-off voltage	V_{RWM}				12	V
Reverse breakdown voltage	V_{BR}	$I_{BR}=1\text{mA}$	13.3			V
Reverse leakage current	I_R	$V_R=12\text{V}$ Each I/O pin			1	μA
Clamping voltage ($t_p=8/20\mu\text{s}$)	V_C	$I_{PP}=1\text{A}$			19	V
Clamping voltage ($t_p=8/20\mu\text{s}$)	V_C	$I_{PP}=5\text{A}$			32	V
Off state junction capacitance	C_J	0Vdc, f=1MHz Between I/O pins and GND		65		pF

SDT23C15L02 (Marking: C15)

Parameter	Symbol	Condition	Min.	Typ.	Max.	Unit
Reverse stand-off voltage	V_{RWM}				15	V
Reverse breakdown voltage	V_{BR}	$I_{BR}=1\text{mA}$	16.7			V
Reverse leakage current	I_R	$V_R=15\text{V}$ each I/O pin			1	μA
Clamping voltage ($t_p=8/20\mu\text{s}$)	V_C	$I_{PP}=1\text{A}$			24	V
Clamping voltage ($t_p=8/20\mu\text{s}$)	V_C	$I_{PP}=5\text{A}$			38	V
Off state junction capacitance	C_J	0Vdc, f=1MHz Between I/O pins and GND		60		pF

Typical Characteristics Curves

Figure 1. Power Derating Curve

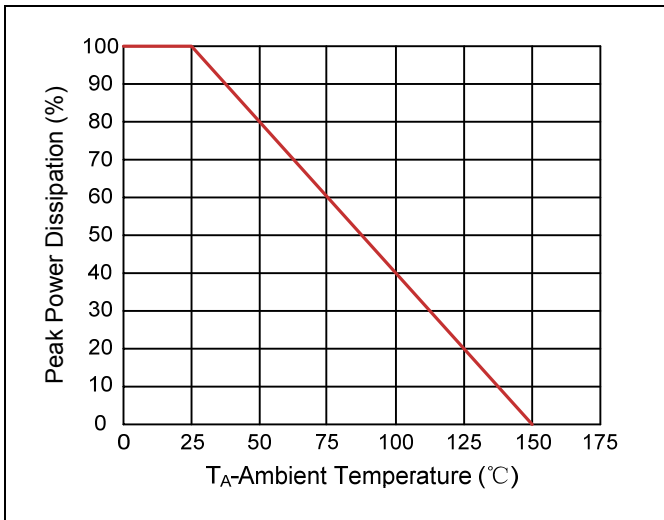

Figure 2. Pulse Waveforms

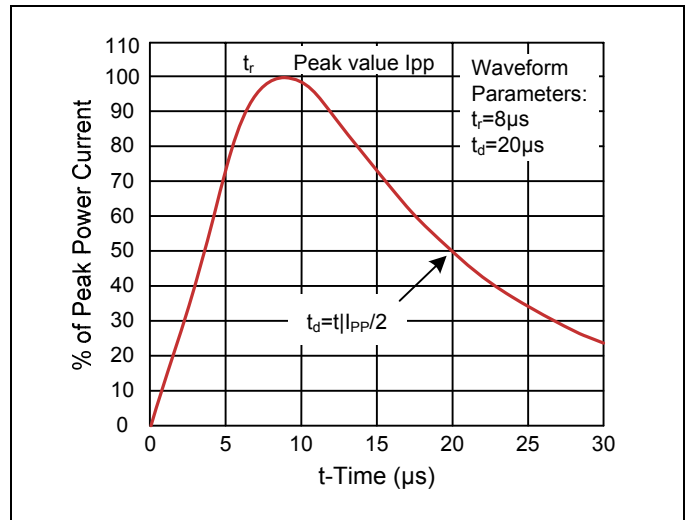

Figure 3. Non-Repetitive Peak Pulse vs. Pulse Time

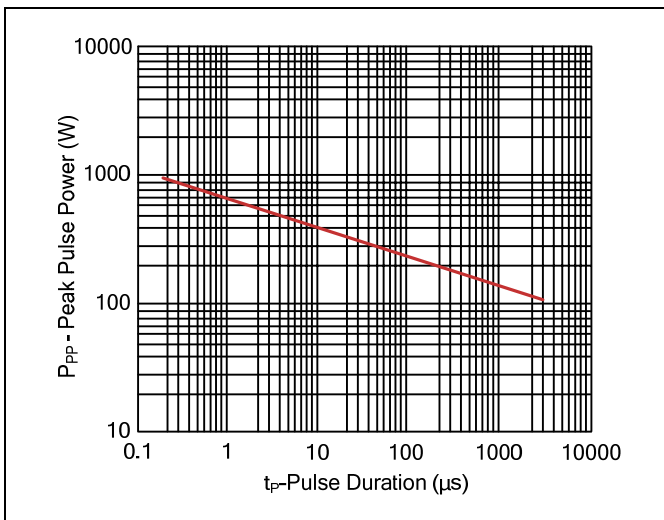

Figure 4. Normalized Capacitance vs. Reverse Voltage

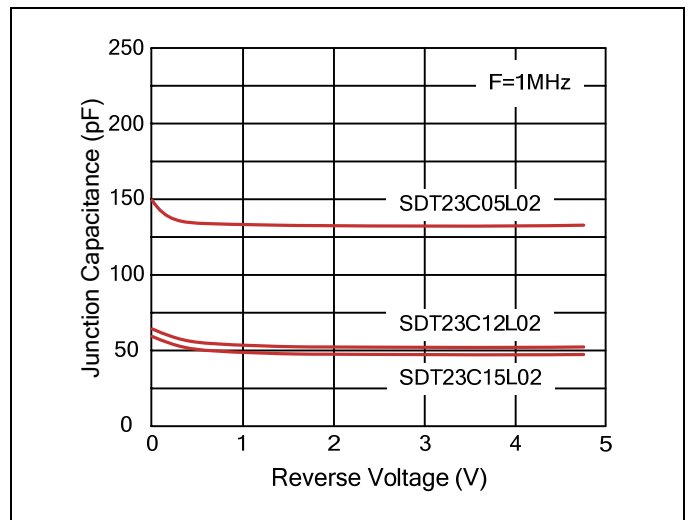

Figure 5. ESD Clamping(8kV Contact IEC61000-4-2)

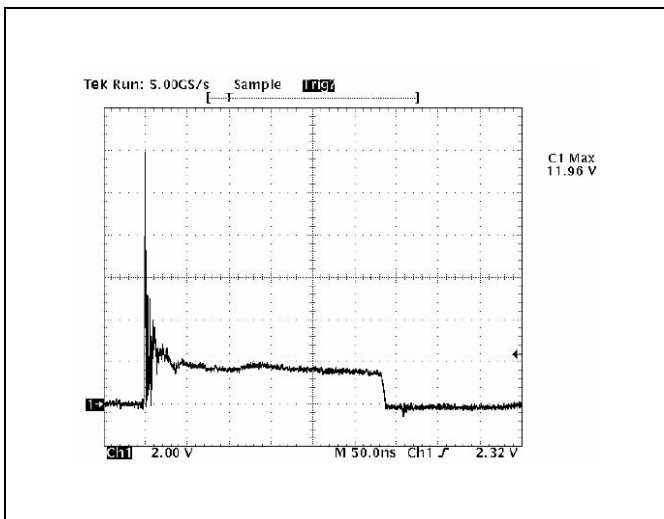
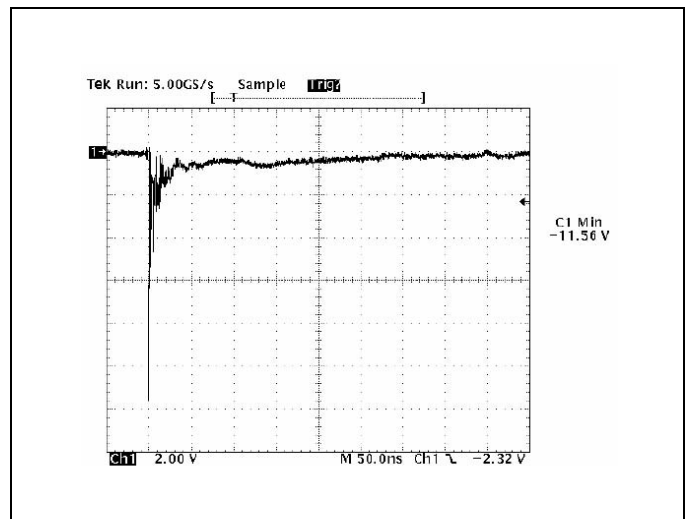
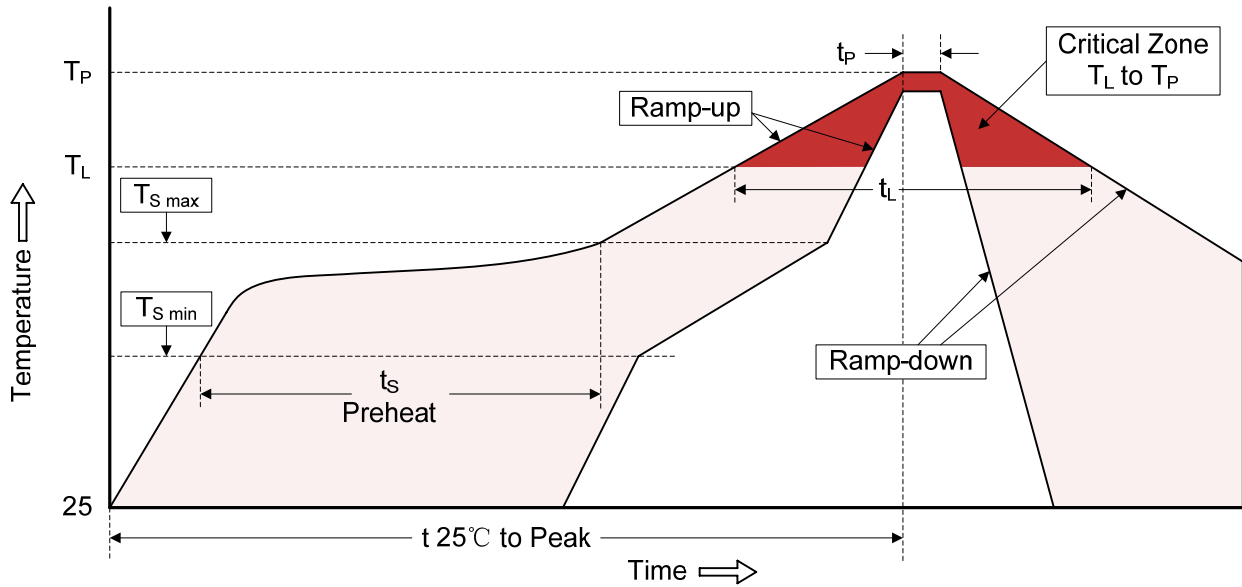

Figure 6. ESD Clamping(-8kV Contact IEC61000-4-2)



Recommended Soldering Conditions

Reflow Soldering



Recommended Conditions

Profile Feature	Pb-Free Assembly
Average ramp-up rate (T_L to T_P)	3°C/second max.
Preheat -Temperature Min ($T_{S\ min}$) -Temperature Max ($T_{S\ max}$) -Time (min to max) (t_s)	150°C 200°C 60-180 seconds
$T_{S\ max}$ to T_L -Ramp-up Rate	3°C/second max.
Time maintained above: -Temperature (T_L) -Time (t_L)	217°C 60-150 seconds
Peak Temperature (T_P)	260°C
Time within 5°C of actual Peak Temperature (t_P)	20-40 seconds
Ramp-down Rate	6°C/second max.
Time 25°C to Peak Temperature	8 minutes max.

Dimensions (SOT-23)

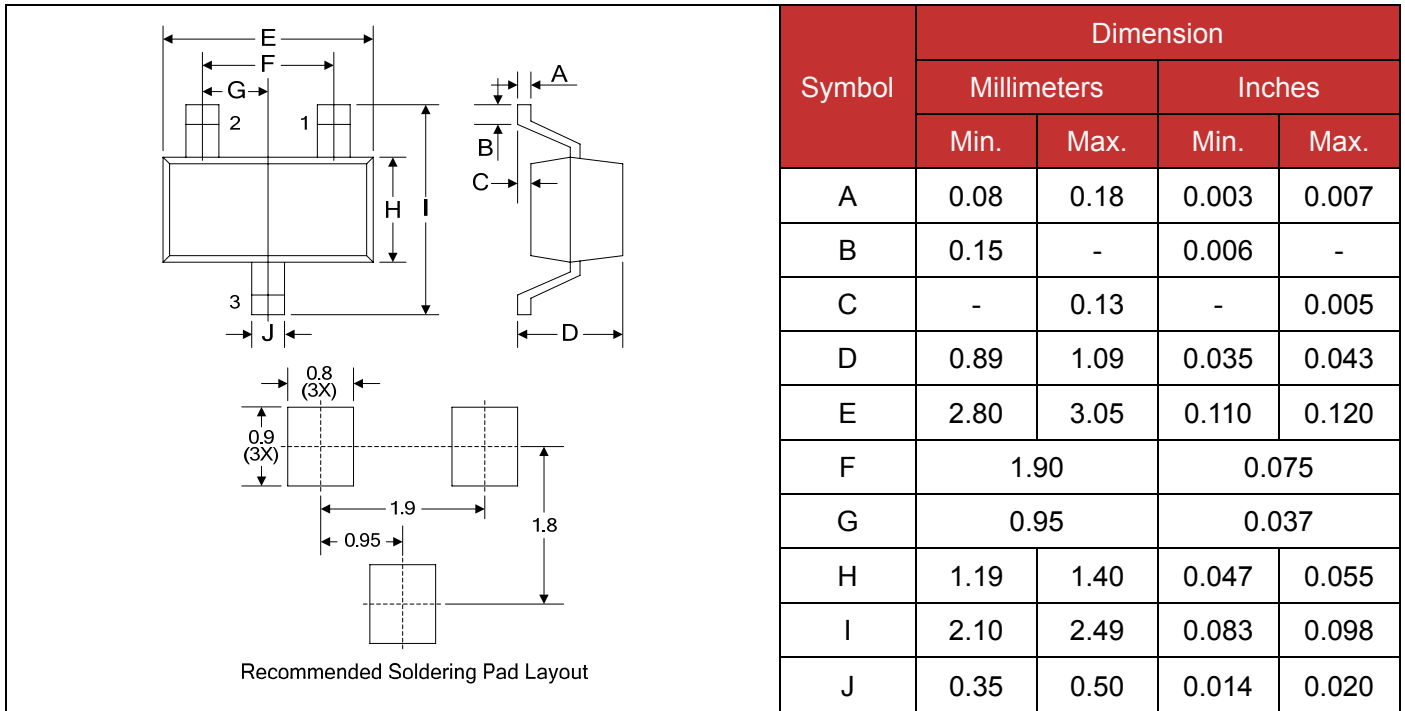

Packaging

